

RODAPÉ DE ALUMÍNIO

ALUMINIUM SKIRTING BOARD | PLINTE EN ALUMINIUM

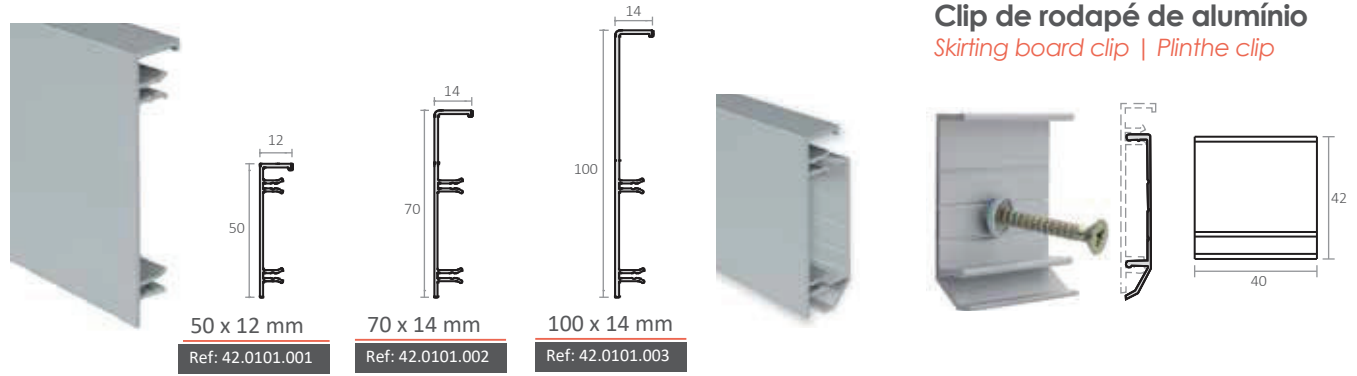

AN **L** 6 Uni.  6 Uni.  6 Uni.  (Distância recomendada entre cliques: cerca de 500 mm) (Recommended distance between clips: about 500 mm) (Distance recommandée entre les clips : environ 500 mm) AN 6 Uni. 

Comprimento | Length | Longueur: 2500 mm

O rodapé de alumínio GS FLOORS é elegante, minimalista e de enorme qualidade. Aplicado em conjunto com o clip de fixação, confere bastante segurança na sua utilização e aderência à parede. Permite armazenar fios e cabos de serviço, ocultando-os da vista, proporcionando uma maior harmonia estética.

En - The GS FLOORS aluminium skirting board is elegant, minimalist and of high quality. Applied together with the fixing clip, it provides high security in its use and adherence to the wall. It allows to hide service wires and cables, providing greater aesthetic harmony.

Fr - La plinthe en aluminium GS FLOORS est élégante, minimaliste et de grande qualité. Appliquée avec le clip de fixation, elle offre beaucoup de sécurité dans son utilisation et son adhérence au mur. Elle permet de ranger les fils et câbles de service, en les cachant de la vue, offrant une plus grande harmonie esthétique.

CANTOS PARA RODAPÉ DE ALUMÍNIO

CORNERS FOR ALUMINIUM SKIRTING | COINS POUR PLINTE EN ALUMINIUM



ABS **C** **L** 1 Uni.  1 Uni.  1 Uni. 

RODAPÉ DE EMBUTIR

WALL FLUSH SKIRTING | PLINTE INVISIBLE

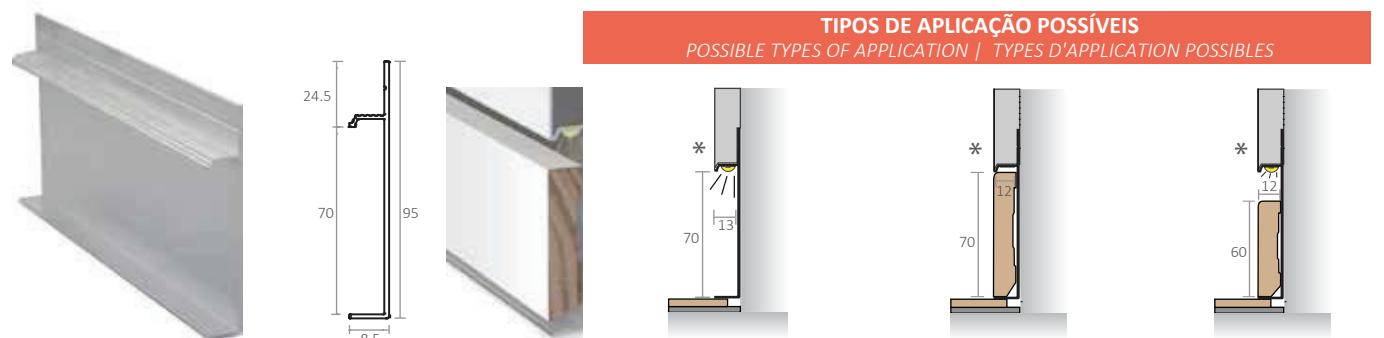

Ref: 42.0101.004

Comprimento | Length | Longueur: 2500 mm

AN **L** 1 Uni. 

- 1 - Embutido simples com ou sem led.
- Simple wall flush skirting with or without led.
- Simple plinthe invisible avec or sans led.
- 2 - Com rodapé madeira sem led.
- With wooden skirting board without led.
- Avec plinthe de bois sans led.
- 3 - Com rodapé madeira com led.
- With wooden skirting board and led.
- Avec plinthe bois et led.

* Rodapé de madeira sob encomenda (disponível apenas em lacado branco).
Wooden skirting board made by order (only available in white lacquered).
Plinthe en bois sur demande (seulement disponible en blanc laqué).









Fita led não incluída.
Led strip not included.
Bande led non inclus.

|  | RODAPÉS Skirtings Plinthes | | PERFIS DE REMATE Aluminium Profiles Profils en aluminium | | | | | |
|---|---------------------------------|-----------------------------------|---|--|--|-----------------------------|--|--|
| | WPC WPC Pag. 13 | Madeira Wood Bois Pag. 13 | LVT / SPC LVT / SPC Pag. 15 | Alumínio c/ base PVC Aluminium w/ PVC base Aluminium av/ base PVC Pag. 16 | Perfil e base PVC Profile and PVC base Profil et base PVC Pag. 17 | Tapite Tapite Pag. 18 | Terminal End Profile Finition Pag. 19 | Base alumínio Aluminium base Base aluminium Pag. 20 |

PVC GAMA PVC | PVC Gamma | Gamme PVC

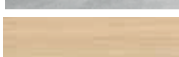







| | | WPC | Madeira | LVT / SPC | Alumínio c/ base PVC | Perfil e base PVC | Tapite | Terminal | Base alumínio |
|---|---|-----|---------|-----------|----------------------|-------------------|--------|----------|---------------|
|  | Carvalho Branco White Oak Chêne Blanc | ✓ | ✓ | — | ✓ | ✓ | ✓ | ✓ | ✓ |
|  | Carvalho Reconst. Rebuilt Oak Chêne Reconst. | ✓ | ✓ | — | ✓ | ✓ | ✓ | ✓ | ✓ |
|  | Carvalho 2 2 Oak Chêne 2 | ✓ | ✓ | — | ✓ | ✓ | ✓ | ✓ | ✓ |
|  | Cerejeira Cherry Cerisier | ✓ | ✓ | — | ✓ | ✓ | ✓ | ✓ | ✓ |
|  | Faia Vaporizada Streamed beech Hêtre étuvé | ✓ | ✓ | — | ✓ | ✓ | ✓ | ✓ | ✓ |
|  | Mogno Mahogany Acajou | ✓ | ✓ | — | ✓ | ✓ | ✓ | ✓ | ✓ |
|  | Nogueira Walnut Noyer | ✓ | ✓ | ✓ | ✓ | ✓ | ✓ | ✓ | ✓ |
|  | Prata II II Silver Argent II | ✓ | ✓ | — | — | — | — | — | — |
|  | Sucupira Sucupira | ✓ | ✓ | — | ✓ | ✓ | ✓ | ✓ | ✓ |
|  | Teka Teak Teck | ✓ | ✓ | — | ✓ | ✓ | ✓ | ✓ | ✓ |
|  | Wengue Wenge Wenge | ✓ | ✓ | — | ✓ | ✓ | ✓ | ✓ | ✓ |

VIN GAMA VINIL | Vinyl Gamma | Gamme Vinyle

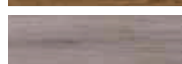

| | | WPC | Madeira | LVT / SPC | Alumínio c/ base PVC | Perfil e base PVC | Tapite | Terminal | Base alumínio |
|---|---|-----|---------|-----------|----------------------|-------------------|--------|----------|---------------|
|  | Branco Artic Artic White Blanc Artic | ✓ | ✓ | — | — | — | — | — | — |
|  | Branco Pérola Pearl White Blanc Perla | ✓ | ✓ | — | — | — | — | — | — |
|  | Carvalho Antiqua Antiqua Oak Chêne Antiqua | ✓ | ✓ | — | — | — | — | — | — |
|  | Carvalho Brown Brown Oak Chêne Brun | ✓ | ✓ | — | — | — | — | — | — |
|  | Carvalho Natural Natural Oak Chêne Natural | ✓ | ✓ | — | — | — | — | — | — |
|  | Carvalho Plomo Plomb Oak Chêne Plomb | ✓ | ✓ | — | — | — | — | — | — |
|  | Carvalho Savannah Savannah Oak C. Savannah | ✓ | ✓ | — | — | — | — | — | — |
|  | Concrete Concrete Béton | ✓ | ✓ | — | — | — | — | — | — |
|  | Moldau Acacia Moldau Acacia | ✓ | ✓ | — | — | — | — | — | — |
|  | Nogueira Cacao Cacao Walnut Noyer Cacao | ✓ | ✓ | — | — | — | — | — | — |
|  | Olmo Gris Grey Elm Orme Gris | ✓ | ✓ | — | — | — | — | — | — |
|  | Olmo Escuro Dark Elm Orme Foncé | ✓ | ✓ | — | — | — | — | — | — |
|  | Olmo Taupe Taupe Elm Orme Taupe | ✓ | ✓ | — | — | — | — | — | — |
|  | Silver Light Silver Light Argent Light | ✓ | ✓ | — | — | — | — | — | — |
|  | Light Grey Light Grey | ✓ | ✓ | — | — | — | — | — | — |
|  | Linho Dark Grey Dark Grey Linen Lin Gris Foncé | ✓ | ✓ | — | — | — | — | — | — |

| GS floors Flooring solutions by gosimat | RODAPÉS Skirtings Plinthes | | PERFIS DE REMATE Aluminium Profiles Profils en aluminium | | | | | | |
|--|---------------------------------|-----------------------------------|---|--|--|-----------------------------|--|--|--|
| | WPC WPC Pag. 13 | Madeira Wood Bois Pag. 13 | LVT / SPC LVT / SPC Pag. 15 | Alumínio c/ base PVC Aluminium w/ PVC base Aluminium av/ base PVC Pag. 16 | Perfil e base PVC Profile and PVC base Profil et base PVC Pag. 17 | Tapite Tapite Pag. 18 | Terminal End Profile Finition Pag. 19 | Base alumínio Aluminium base Base aluminium Pag. 20 | |

LVT GAMA DECOR - LVT | LVT Decor Gamma | Gamme Decor - LVT

| | | | | | | | | | |
|---|---------------------------------------|---|---|---|---|---|---|---|---|
|  | Alaska Oak <i>Alaska Oak</i> | ✓ | ✓ | ✓ | ✓ | — | — | — | — |
|  | Antracite Oak <i>Antracite Oak</i> | ✓ | ✓ | ✓ | ✓ | — | — | — | — |
|  | Blond Oak <i>Blond Oak</i> | ✓ | ✓ | ✓ | ✓ | — | — | — | — |
|  | Country Oak <i>Country Oak</i> | ✓ | ✓ | ✓ | ✓ | — | — | — | — |
|  | Fox Oak <i>Fox Oak</i> | ✓ | ✓ | ✓ | ✓ | — | — | — | — |
|  | Golden Oak <i>Golden Oak</i> | ✓ | ✓ | ✓ | ✓ | — | — | — | — |
|  | Nordic Oak <i>Nordic Oak</i> | ✓ | ✓ | ✓ | ✓ | — | — | — | — |
|  | Sand Oak <i>Sand Oak</i> | ✓ | ✓ | ✓ | ✓ | — | — | — | — |
|  | Tobacco Oak <i>Tobacco Oak</i> | ✓ | ✓ | ✓ | ✓ | — | — | — | — |

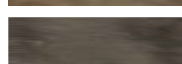
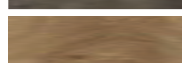
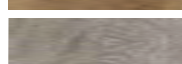
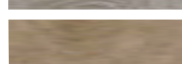
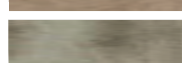
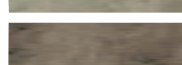
SPC GAMA DECOR - SPC | SPC Decor Gamma | Gamme Decor - SPC

| | | | | | | | | | |
|---|-------------------------------------|---|---|---|---|---|---|---|---|
|  | Arizona Oak <i>Arizona Oak</i> | ✓ | ✓ | ✓ | ✓ | — | — | — | — |
|  | Graphite Oak <i>Graphite Oak</i> | ✓ | ✓ | ✓ | ✓ | — | — | — | — |
|  | Honey Oak <i>Honey Oak</i> | ✓ | ✓ | ✓ | ✓ | — | — | — | — |
|  | Iron Oak <i>Iron Oak</i> | ✓ | ✓ | ✓ | ✓ | — | — | — | — |
|  | Nature Oak <i>Nature Oak</i> | ✓ | ✓ | ✓ | ✓ | — | — | — | — |
|  | Pearl Oak <i>Pearl Oak</i> | ✓ | ✓ | ✓ | ✓ | — | — | — | — |
|  | Smoked Oak <i>Smoked Oak</i> | ✓ | ✓ | ✓ | ✓ | — | — | — | — |
|  | Vanilla Oak <i>Vanilla Oak</i> | ✓ | ✓ | ✓ | ✓ | — | — | — | — |

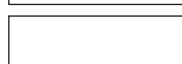
| | | | | | | | | | |
|---|---|---|---|---|---|---|---|---|---|
|  | Decor Branco <i>White Decor Decor Blanc</i> | ✓ | ✓ | — | — | — | — | — | — |
|  | Lacado Branco <i>White Lacquered Laqué blanc</i> | ✓ | ✓ | — | — | — | — | — | — |

| | | | | | | | | | |
|---|---|---|---|---|---|---|---|---|---|
|  | Alumínio anodizado <i>Anodized alum. Alum. anodisé</i> | — | — | ✓ | ✓ | ✓ | ✓ | ✓ | ✓ |
|---|---|---|---|---|---|---|---|---|---|

NOTAS | NOTES

A reprodução de cores é meramente ilustrativa. | The color reproduction is merely illustrative. | La reproduction des couleurs est simplement illustrative.

Os artigos expostos neste catálogo estão limitados ao stock existente.

The products displayed on this catalog are limited to existing stock. | Les articles publiés dans ce catalogue sont limités au stock existant.

A GS FLOORS reserva-se o direito de alterar ou eliminar, total ou parcialmente, qualquer gama, referência ou especificação técnica contida neste catálogo.

The GS FLOORS reserves the right to change or remove all or part of any range, reference or technical specifications contained in this catalog.

GS FLOORS réserve le droit de modifier ou de supprimer, en tout ou en partie, quelque une gamme, référence ou spécification technique contenues dans ce catalogue.